

Your First Choice and Best Solutions of
Bluetooth Barcode Scanners

Wireless BT Series



TYSSO®

Insist on the Best



USB Receiver



KB Receiver

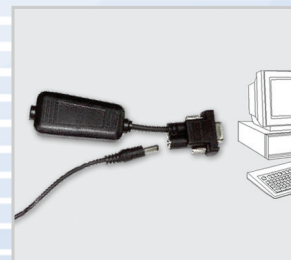

RS232 Receiver

Bluetooth extra long range CCD and laser scanners

FEATURES

- Bluetooth class 1, serial port profile support
- Working range up to 50m or possibly to 70m in open environment
- Keyboard wedge, RS-232 and USB interface available
- Small foot-print cable-like receiver fits well to the computer
- Batch, on-line and recapture operational modes provided
- Over 40,000 scans per recharge, charged by USB power retrieving cable or external power adpater
- Large memory capacity which stores over 15,000 labels (EAN 13 barcode)
- RSS symbologies and other common barcodes decoding
- Low aquisition cost



SPECIFICATIONS

Operation

Nominal Scan Rate	100 scans/sec.
Wavelength	660nm ±10nm for CCD model 670nm ±10nm for laser model
Maximum Pitch	± 65 degrees
Minimum Skew	± 50 degrees
Minimum Bar Width	4 mil
Scan Patten	Single scan line
System Interfaces	Keyboard wedge or RS-232 or USB
Indicators	Buzzer and LEDs
Buffer Capacity	192KB offers 15,000 EAN 13 labels storage
RF Standard	Bluetooth R 1.1 (SPP Profile)
RF Frequency	Band 2.4-2.4835GHZ unlicensed ISM band
Working Distance	Max. 50m, possibly over 70m in open space environment
Readable Bar Code Symbolologies	RSS Codes, EAN, UPC, I 2 of 5, Codabar, Code 39, Code 128, China Postage, Code 93, Code 11, MSI-Plessy, Code 4

Electrical

Input Voltage	Scanner: +5VDC ±5% Receiver: +5VDC ±5%
Power Consumption (CCD model)	Scanner operating with Bluetooth on: 190mA Scanner operating with Bluetooth off: 160mA Scanner sleep with Bluetooth on: 30mA Scanner sleep with Bluetooth off: 2mA
Power Consumption (Laser model)	Scanner operating with Bluetooth on: 160mA Scanner operating with Bluetooth off: 130mA Scanner sleep with Bluetooth on: 30mA Scanner sleep with Bluetooth off: 2mA

Battery

Battery Type	Lithium-ion
Battery Capacity	1100mAh good for 40,000 scans per recharge
Charge	By USB power retrieving cable or external power adapter
Time of Charge	About 4 hours

Operating Environment

Operating Temperature	0°C to 40°C (32°F~104°F)
Storage Temperature	-20°C to 65°C (-8°F~149°F)
Relative Humidity	5% to 95% noncondensing
EMI Emission	FCC class A
Ambient Light	3,000 to 8,000 lux

Model Number

BT-4500-X Extra Long Range CCD scanner series
 ---- K = keyboard wedge
 ---- R = RS-232
 ---- U = USB

BT-3800-X Laser scanner series
 ---- K = keyboard wedge
 ---- R = RS-232
 ---- U = USB

BT-4500 Scan Zone (Based on 90% code 39 barcode)

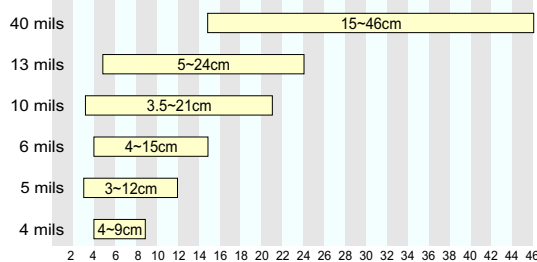

BT-3800 Scan Zone (Based on 90% code 39 barcode)

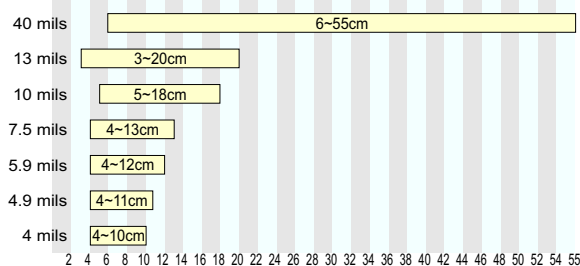

DIMENSIONS (mm)

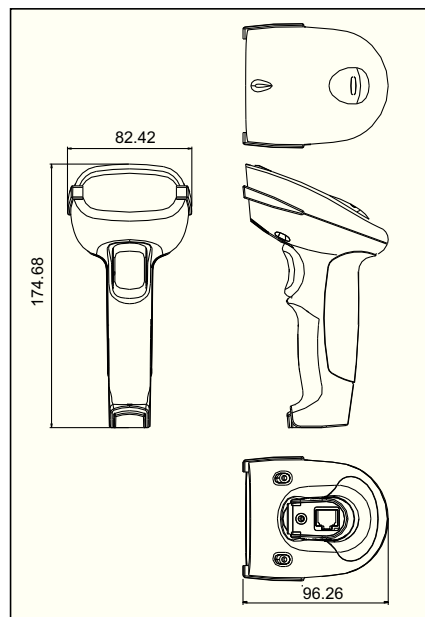

Keyboard wedge receiver

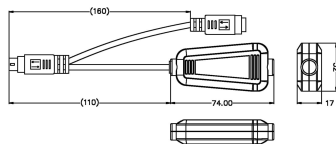

USB receiver

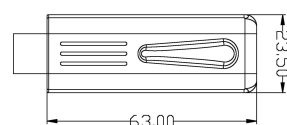

RS-232 receiver

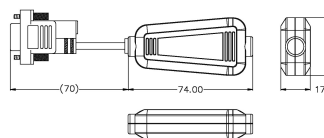

TYSSO®

Insist on the Best

Manufacturer

FAMETECH INC.

2F, No. 165, Sec. 2, Ta-Tung Rd.,
Hsi-Chih 221, Taipei Hsien, Taiwan

Tel : 886-2-8692-6300

Fax: 886-2-8692-6301

E-Mail: tyssso@ms6.hinet.net

URL: http://www.famotech.com.tw

